

Varenummer: 0108047
 Beskrivelse: Seeger låsering JK 30 DIN 984

Mål

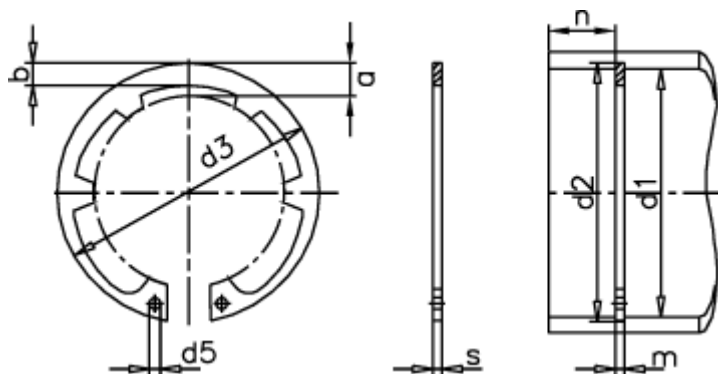

a max	= 4.9	d5 min	= 2.0	s	= 1.20
AN mm ²	= 67.5	FN kN	= 11.3	t	= 0.70
Antal takker	= 6	FRg kN	= 4.6	Tang	= ZGJ-2
b	= 3.2	FR kN	= 13.7	tol	= -0.06
Betegnelse	= JK 30	g	= 1.0	tol	= +0,50-0,25
d1	= 30	K kN-mm	= 26.6	tol	= +0,25
d2	= 31.4	m min	= 1.30	vægt kg/1000	= 2.35
d3	= 32.1	Nominal træk	= 2.1		